



CAT3 RJ14 Keystone Jack



Applications

The Vericom VGC™ Category 3 Unshielded RJ14 Keystone Jacks support 10BASE-T Ethernet for voice and data communications in computer and telecommunications networks in commercial and residential environments.

Description / Specifications

The Vericom VGC™ Category 3 Unshielded RJ14 Keystone Jacks are designed to meet and exceed Category 3 electrical performance requirements for frequencies up to 16 MHz. These modules would traditionally be used with a POTS for Analog and DSL. These keystone jacks are compatible with most manufacturers' faceplates, are easy to punch down, and are labeled for RJ14.

To maximize performance, combine with Vericom patch panels, patch cords (TRJ14-xxxxx), and bulk cable (MBW3U-01633).

For quick and easy termination, pair with our VGC™ Deluxe 66/110 Type Punch Down Tool (Item No. WTPDT-03633).



TECHNICAL SHEETS ARE SUBJECT TO CHANGE WITHOUT NOTICE.

Features & Benefits

- Rated for CAT3 network applications
- Wiring label for traditional RJ14 configuration.
- 110 IDCs are technician friendly with a standard punchdown tool.
- Retention cap secures terminations for long term reliability
- Compatible with most manufacturers' faceplates
- Sold individually

Standards Compliance

- RoHS Compliant
- ANSI TIA/EIA-568 C
- ISO/IEC 11801
- IEC 61156-5

Related Products

VGS™ Universal Modular Patch Panels

*24 Port Item No. UPP6001-24
48 Port Item No. UPP6001-48

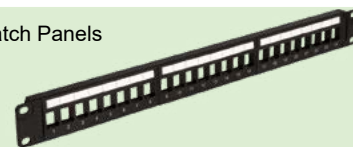

VGC™ Universal 24 Port Modular Patch Panel

Item No. MPPKU-04040

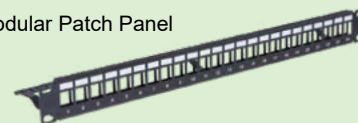

Single Gang Keystone Wall Plates, White

*1 Port: Item No. XFPOP-00470
2 Port: Item No. XFPOP-00471
3 Port: Item No. XFPOP-00472
4 Port: Item No. XFPOP-03418
6 Port: Item No. XFPOP-03421



Single Gang Keystone Wall Plates with Labels
Available in: White

*1 Port: Item No. FP2WH1VL
2 Port: Item No. FP2WH2VL
3 Port: Item No. FP2WH3VL
4 Port: Item No. FP2WH4VL
6 Port: Item No. FP2WH6VL



* Pictured

REV.20250107.3



CAT3 RJ14 Keystone Jack

Ordering Information

Description	Item Number	Color
CAT3 Unshielded RJ14 Keystone Jack	MKJ3U-03571	White

Construction

Housing & Cap: Polycarbonate (PC)

IDC: 110 type, phosphor bronze alloy with tin plating

Contacts: Phosphor bronze alloy plated with gold over nickel plating

Mechanical

Plug Retention: 75 N (17 lbf)

Wire Compatibility: 22 to 26 AWG (0.644 to 0.405 mm)

Mating Life Cycle: Min 750 cycles

Environmental Conditions

Operating Temperature: -22 °F to 140 °F (-30 °C to 60 °C)

Storage Temperature: -22 °F to 140 °F (-30 °C to 60 °C)

Technical Illustration

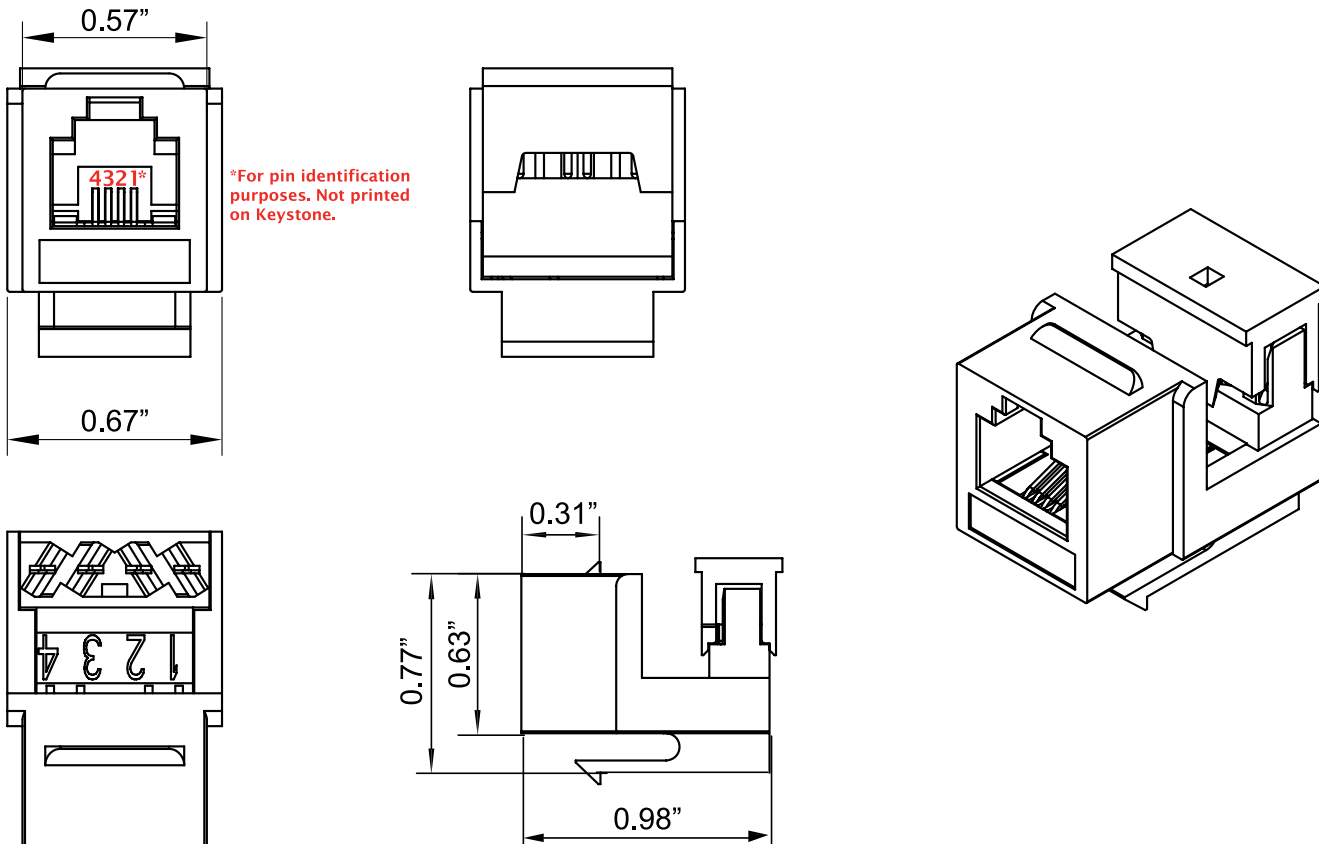

TECHNICAL SHEETS ARE SUBJECT TO CHANGE WITHOUT NOTICE.

REV.20250107.3